

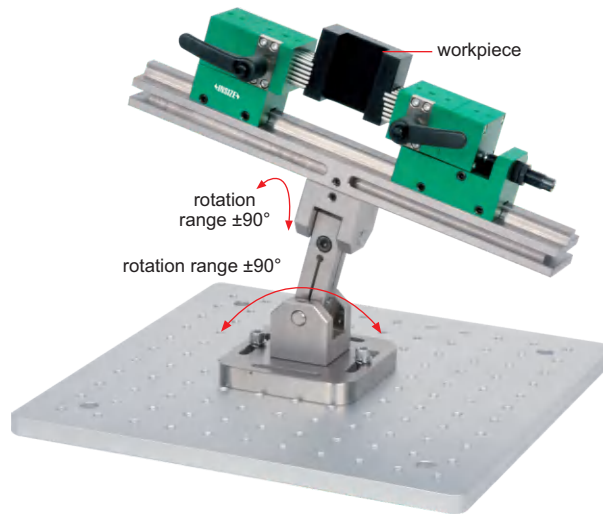

CAN BE
CUSTOMIZED

JIGS FOR CMM (ANVIL Ø2.5mm)



ISY-200

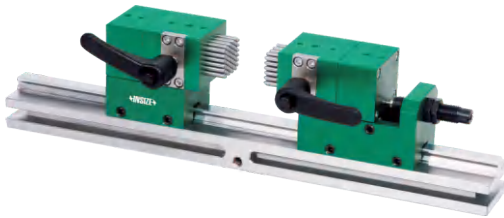

ISY-200-A



ISY-200-3



ISY-200-5

Code	Product	Remark
ISY-200	3-piece jig set	including 1 pc ISY-200-A, 1 pc ISY-200-3, 1 pc ISY-200-5

(mm)

Code	Product	Clamping range	Anvil area	Anvil stroke
ISY-200-A	jigs for cmm	0~170	20.5×23.3	12

(mm)

Code	Product	Size	Hole size
ISY-200-3	base plate	300×300×12	M6

(mm)

Code	Product	Size
ISY-200-5	two-way adjustable stand	95×95×134.5

JIGS FOR CMM (ANVIL Ø6mm)

CAN BE CUSTOMIZED

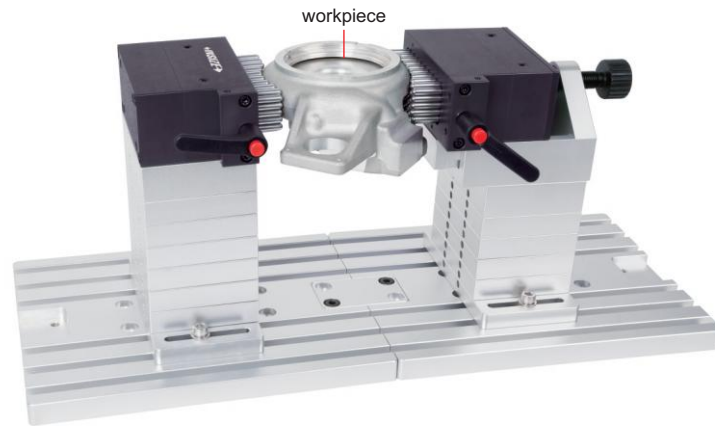

ISY-500



ISY-500-1



ISY-500-2



ISY-500-3



ISY-500-4



ISY-500-5



ISY-500-6



ISY-500-7

Code	Product	Remark
ISY-500	19-piece jig set	including 1 pc ISY-500-1, 1 pc ISY-500-2, 2 pcs ISY-500-3, 10 pcs ISY-500-4, 2 pcs ISY-500-5, 1 pc ISY-500-6, 2 pcs ISY-500-7

Code	Product	Size	Anvil area	Anvil stroke
ISY-500-1	spring anvil	134×90×90	36×100	24
ISY-500-2	adjustable spring anvil (range 0-40mm)	134×120×130	36×100	24

(mm)

Code	Product	Size
ISY-500-3	base plate	300×240×20
ISY-500-4	block	120×90×20
ISY-500-5	connecting plate	170×90×15
ISY-500-6	connecting block of base plate	80×50×10
ISY-500-7	clamp handle	—

(mm)



CAN BE CUSTOMIZED

JIGS FOR CMM (ANVIL Ø2.5mm)



ISY-300-1



ISY-300



ISY-300-2



ISY-300-3



ISY-300-4



ISY-300-5



ISY-300-6



ISY-300-7



ISY-300-8



ISY-300-9



ISY-300-10



ISY-300-11



ISY-300-12



ISY-300-13

Code	Product	Remark
ISY-300	46-piece jig set	including 1 pc ISY-300-1, 2 pcs ISY-300-2, 1 pc ISY-300-3, 2 pcs ISY-300-4, 14 pcs ISY-300-5, 2 pcs ISY-300-6, 8 pcs ISY-300-7, 6 pcs ISY-300-8, 2 pcs ISY-300-9, 2 pcs ISY-300-10, 2 pcs ISY-300-11, 2 pcs ISY-300-12, 2 pcs ISY-300-13

Code	Product	Size	Hole size
ISY-300-1	base plate	300×300×12mm	M8

Code	Product	Size	Anvil area	Anvil stroke
ISY-300-2	spring anvil	60×40×75	20.5×23	14
ISY-300-3	spring anvil	Ø26×73	3.1cm ² (hexagon)	14

Code	Product	Size (mm)
ISY-300-4	block	50×50×50
ISY-300-5	block	50×50×20
ISY-300-6	connecting plate	110×50×10
ISY-300-7	block	Ø26×20
ISY-300-8	block	Ø26×30
ISY-300-9	connecting plate	150×26×10
ISY-300-10	clip	65×11
ISY-300-11	clip	100×11
ISY-300-12	connecting block of clip stand	Ø26×20
ISY-300-13	clip stand	Ø8×75

JIGS FOR CMM (ANVIL Ø6mm)

CAN BE CUSTOMIZED

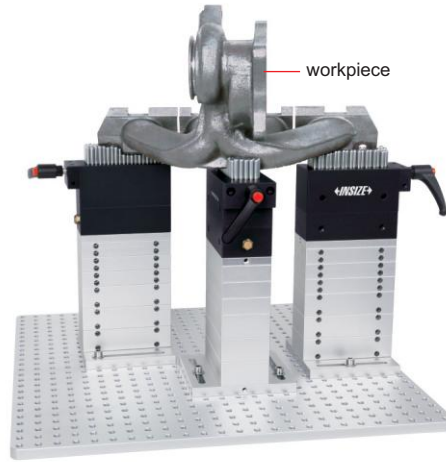

ISY-400



ISY-400-1



ISY-400-2



ISY-400-3

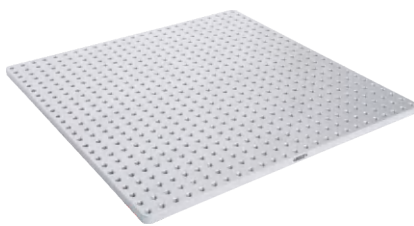

ISY-400-4



ISY-400-5



ISY-400-6

Code	Product	Remark
ISY-400	28-piece jig set	including 3 pcs ISY-400-1, 9 pcs ISY-400-2, 9 pcs ISY-400-3, 1 pc ISY-400-4, 3 pcs ISY-400-5, 3 pcs ISY-400-6

(mm)

Code	Product	Size
ISY-400-2	block	120×60×20
ISY-400-3	block	120×60×30
ISY-400-4	base plate	500×500×12
ISY-400-5	connecting plate	130×120×12
ISY-400-6	clamp handle	—

(mm)

Code	Product	Size	Anvil area	Anvil stroke
ISY-400-1	spring anvil	135×60×90	36×100	24



158-PIECE JIG SET FOR CMM CODE ISY-100

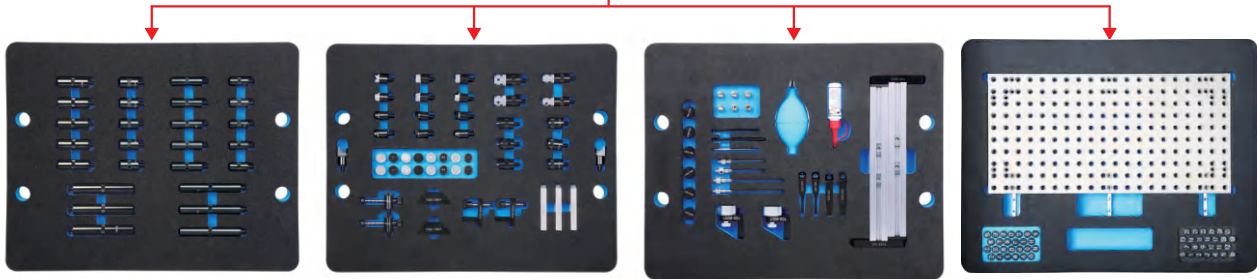

ISY-100

application examples

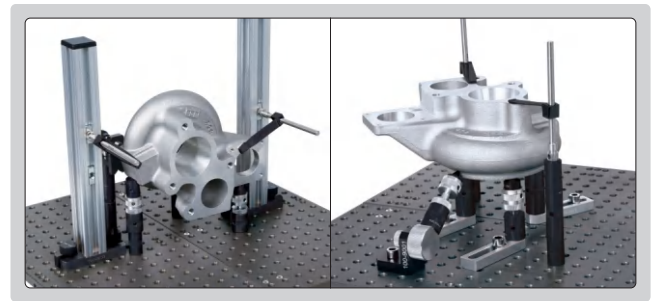

Product	Code	Size (mm)	Quantity	Application
	ISY-100-1001	Ø16×30	5	
	ISY-100-1002	Ø16×50	5	
	ISY-100-1003	Ø16×100	3	
	ISY-100-1004	Ø20×30	5	
	ISY-100-1005	Ø20×50	5	
	ISY-100-1006	Ø20×100	3	
stand with fine adjustment	ISY-100-2001	Ø16×45~60	2	height adjustment: 45~60mm
stand with fine adjustment	ISY-100-2003	Ø20×45~60	2	
horizontal spring stand	ISY-100-4001	—	2	

Product	Code	Size (mm)	Quantity	Application
horizontal screw stand	ISY-100-5001	—	2	
magnetic stand (magnetic top surface)	ISY-100-7001	Ø20×25	3	
stand for slice parts	ISY-100-8001	Ø20×25	2	ISY-100-8001 and ISY-100-8002 use cooperatively
clamping stand for slice parts	ISY-100-8002		1	









To be continued

Continued from previous page

Product	Code	Size (mm)	Quantity	Application
clip 	ISY-100-1201	—	2	
clip 	ISY-100-1301	—	2	
clip stand 	ISY-100-1401	Ø6×60	2	
	ISY-100-1402	Ø6×100	2	
vertical square column 	ISY-100-3003	30×30×250	2	
sliding support plate 	ISY-100-1801	78×20×10	3	
clamping screw 	ISY-100-2301	Ø8×20	6	
screw 	ISY-100-2302	Ø8×20	6	
base plate 	ISY-600-400200	400×400×12 hole size: M8×1.25 hole center distance: 20	2 pieces	—
wrench 	ISY-100-3701	Ø3.8×70	1	—
wrench 	ISY-100-3801	M2.5	1	—
	ISY-100-3802	M5	1	—
	ISY-100-3803	M6	1	—
45° stand 	ISY-100-9001	—	2	
V shaped support 	ISY-100-1901	—	2	

Product	Code	Quantity	Application
V shaped support 	ISY-100-1902	2	
marker 	ISY-6100-1501	52*	
dust cleaner 	ISY-100-3501	1	—
lubricating oil 	ISY-100-3601	1	—

* Letter A-Z, number 0-25

Product	Code	Quantity	Material	Application
support head 	ISY-100-27016	2	aluminum	
	ISY-100-27018	2	nylon	
support head 	ISY-100-27026	2	aluminum	
	ISY-100-27028	2	nylon	
support head 	ISY-100-27036	2	aluminum	
	ISY-100-27038	2	nylon	
support head 	ISY-100-27046	2	aluminum	
	ISY-100-27048	2	nylon	
support head 	ISY-100-27056	2	aluminum	
	ISY-100-27058	2	nylon	
support head 	ISY-100-27066	2	aluminum	
	ISY-100-27068	2	nylon	
support head 	ISY-100-27076	2	aluminum	
	ISY-100-27078	2	nylon	



99-PIECE JIG SET FOR CMM CODE ISY-600



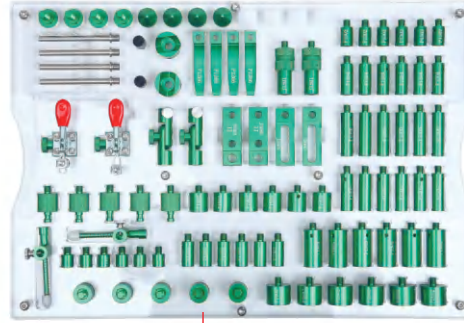



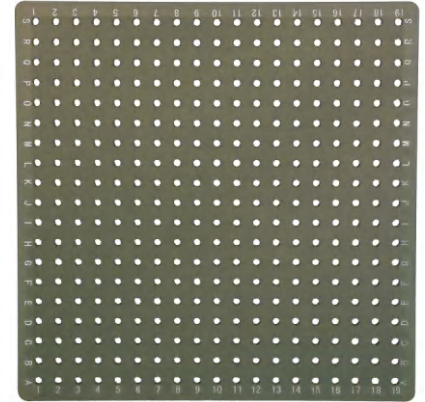



application example











acrylic tray (included)



ISY-600

Product	Code	Size (mm)	Quantity
stand 	ISY-600-P1301	Ø13×13	6
	ISY-600-P1302	Ø13×20	6
	ISY-600-P1303	Ø13×26	6
stand 	ISY-600-P1304	Ø13×32	6
	ISY-600-P1305	Ø13×40	6
	ISY-600-P1306	Ø13×45	6
stand 	ISY-600-P1902	Ø20×20	6
	ISY-600-P1905	Ø20×38	6
	ISY-600-P2602	Ø26×20	6
spring stand 	ISY-600-P1522	—	2
universal support 	ISY-600-J1560	—	2
stand with fine adjustment 	ISY-600-J1501	48~60	2
magnetic stand (magnetic top surface) 	ISY-600-J2020	Ø20×20	5
adaptor 	ISY-600-J2021	Ø20×19	5
V shaped support 	ISY-600-J2520	Ø25×20	2
clamping screw 	ISY-600-P2003	M8x1.25	4

Product	Code	Size (mm)	Quantity
sliding support plate 	ISY-600-J2060	60×20×10	2
sliding support plate 	ISY-600-J2060-2	60×20×10	2
clip 	ISY-600-P1266	12×66	4
chuck support 	ISY-600-JS201	—	2
clip stand 	ISY-600-P0684	Ø6×74	4
aluminum support head 	ISY-600-P2002	—	4
nylon support head 	ISY-600-P2001	—	4
base plate 	ISY-600-400	400×400×18 hole size: M8X1.25	1

113-PIECE JIG SET FOR VISION MEASURING SYSTEMS CODE ISY-700

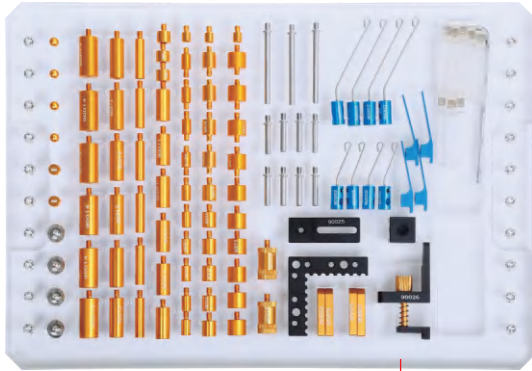



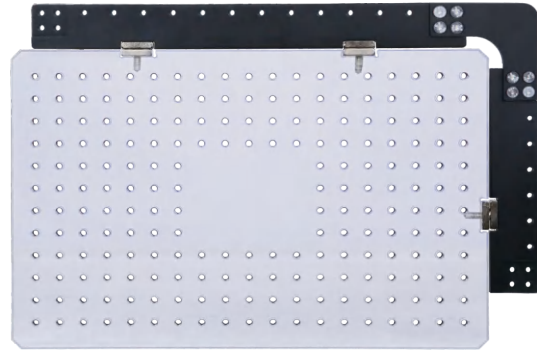





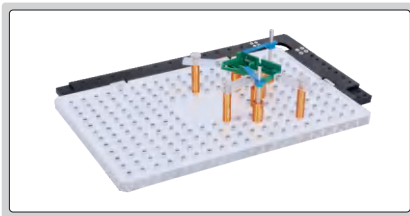

acrylic tray (included)

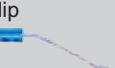

ISY-700

application example



Product	Code	Size (mm)	Quantity
clip 	ISY-700-90001	7×34	4
clip 	ISY-700-90002	Ø1.5×24	4
	ISY-700-90003	Ø1.5×50	4
clip stand 	ISY-700-90004	Ø4×20	8
	ISY-700-90005	Ø4×46	3
spherical support head 	ISY-700-90006	—	4
stand 	ISY-700-90007	Ø6×10	6
	ISY-700-90008	Ø6×25	6
	ISY-700-90019	Ø6×5	3
stand 	ISY-700-90009	Ø9×7	3
	ISY-700-90010	Ø9×10	6
	ISY-700-90011	Ø9×20	6
	ISY-700-90012	Ø9×25	6
stand 	ISY-700-90013	Ø12×10	6
	ISY-700-90014	Ø12×25	6
stand for slice parts 	ISY-700-90015	Ø6×10	4
	ISY-700-90016	Ø9×10	4
	ISY-700-90017	Ø12×10	4
stand with fine adjustment 	ISY-700-90018	Ø12×20~25	2

Product	Code	Size (mm)	Quantity
adapter for square support 	ISY-700-90020	—	2
clamping screw 	ISY-700-90021	—	4
L-shaped positioning plate 	ISY-700-90022	50×50×6	1
sliding support plate 	ISY-700-90023	30×12×5	4
square support 	ISY-700-90024	20×16×16	1
base for square support 	ISY-700-90025	45×16×6	1
spring stand 	ISY-700-90026	—	1
acrylic sliding support plate 	ISY-700-90028	45×12×5	8
wrench 	ISY-700-90029	M3	1
acrylic base plate 	ISY-700-90030	300×200×12 Hole size: M4X0.7	1